

**ComicByte**<sup>®</sup>  
*switch to GOD MODE*

# STELLARIS

3 MODES WIRED + WIRELESS + BLUETOOTH CONTROLLER



**USER MANUAL**

# TECHNICAL SPECIFICATIONS

Input Voltage:	5V, 350mA
Working Voltage:	3.7V
Battery Capacity:	1000mAh
Product Size:	154*59*111mm
Product Weight:	250+10g
Material:	ABS



**ALL IN ONE  
CONTROLLER**



**1000MAH  
BATTERY**



**BACKLIT  
ACTION BUTTONS**



**UPTO 10 METERS  
WIRELESS RANGE**



**DUAL VIBRATION  
MOTORS**



**MAGNETIC  
TRIGGERS**



**MAGNETIC  
JOYSTICKS**



**RGB LED**



# CONTROLLER DESIGN

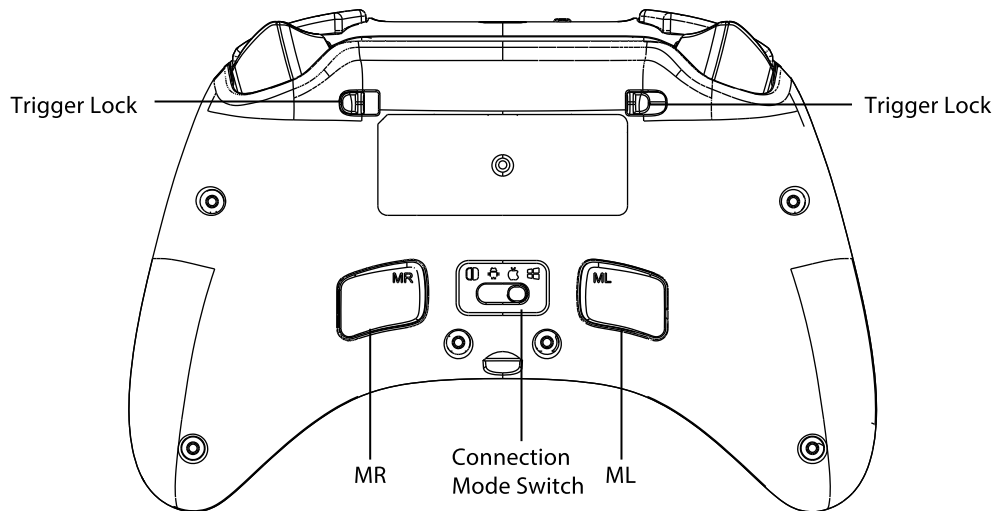
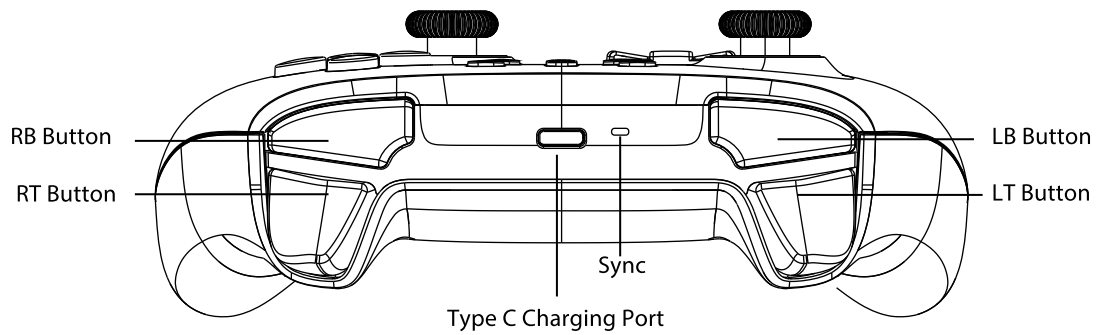
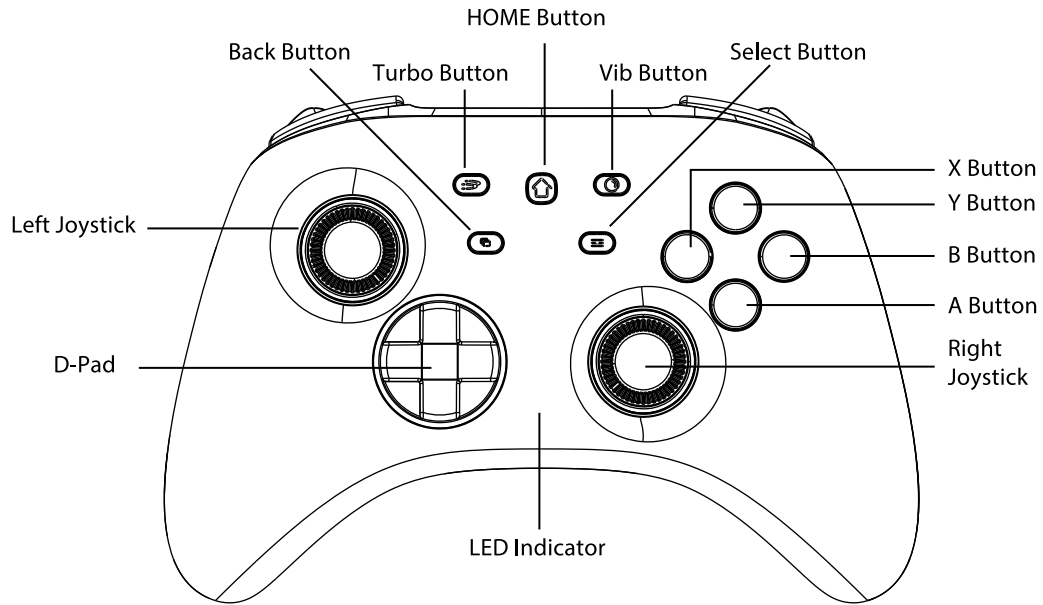

# TURBO AND AUTO FIRE FUNCTIONS

Buttons that can be set as Turbo A/B/X/Y/LB/LT/RB/RT

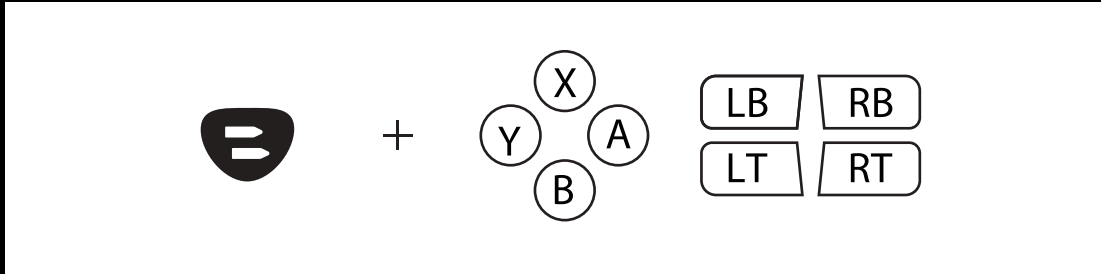

## HOW TO SET UP THE TURBO FUNCTION:

### MANUAL TURBO FUNCTION

Press and hold the Turbo button, then press any function button ONCE to turn on the "Manual Turbo Function"

### AUTO TURBO FUNCTION

Repeat the above again to switch to the "Auto Turbo Function."

### TURN OFF THE TURBO FUNCTION

Repeat the first step again after the "Auto Turbo Function" has been set to turn off turbo.

### TURN OFF THE TURBO FUNCTION FOR ALL BUTTONS:

Press and hold the Turbo button for 6 seconds until the controller vibrates which will turn off the turbo functions of all buttons.

### THERE ARE THREE LEVELS OF TURBO SPEED:

Slow: 5 shots/s, the corresponding LED indicators will flash at a slow speed.

Medium: 15 shots/s, the corresponding LED indicators will flash at a medium speed. (Default Level)

Fast: 25 shots/s, the corresponding LED indicators will flash at a fast speed.

## ADJUST THE TURBO SPEED LEVELS:

Press and hold the Turbo button,

Decrease: Move the RIGHT joystick DOWN to decrease one level of turbo speed

Increase: Move the RIGHT joystick UP to increase one level of turbo speed.

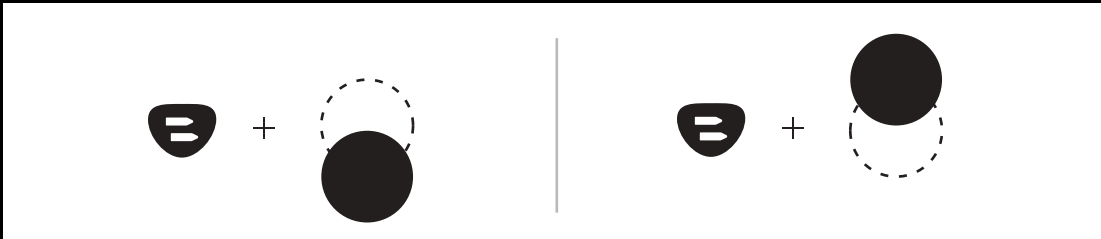

## ADJUSTING VIBRTATION INTENSITY

There Are Four Levels of Vibration Intensity: None, weak, medium, strong.

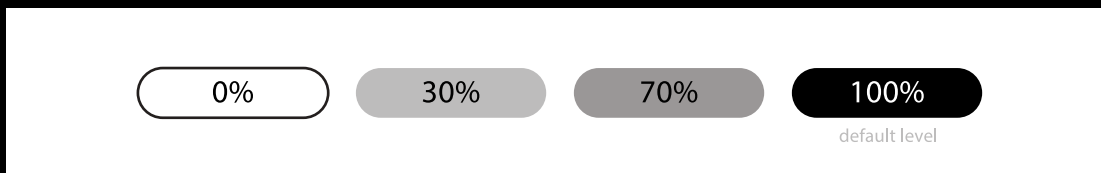

## ADJUST THE VIBRATION INTENSITY:

Press and hold the Turbo button

Increase: Move the LEFT joystick UP to increase one level of vibration intensity.

Decrease: Move the LEFT joystick DOWN to decrease one level of vibration intensity.

## HOW TO INTERCHANGE DPAD AND JOYSTICK FUNCTION

Double Press the "Vib/Capture" to interchange Dpad and Joystick Function.

# MACRO FUNCTIONS

- There are two macro programmable buttons "ML/MR" on the back of the controller.
- Macro buttons can be programmed into function buttons or button sequences respectively.
- Macro buttons can be programmed to: A/B/X/Y/LB/LT/RB/RT/up/down/left/right buttons.
- The default mapping buttons of ML & MR are B & A.

## HOW TO ENTER MACRO MODE AND SET UP THE BUTTON(S) FUNCTIONS:

Press and hold the "Turbo" + "ML/MR button" together for 2 seconds, LED2 LED3 will stay on.

The controller is ready to record the macro settings.

Press the function buttons that need to be set sequentially, the controller will record the buttons with the time interval at which each button is pressed.

Press macro button ML or MR shortly to save, the corresponding LED light will stay on. The macro has been saved. When the controller re-connects to the device, it will automatically apply the last macro settings.

## CLEAR THE MACRO SETTINGS:

Press the "Turbo" + "ML/MR buttons" together for 2 seconds to enter settings mode, the LED2 - LED3 will stay on, then directly exit setting mode by pressing the same ML/MR buttons.

The corresponding LED will light up again. The macro setting within the current slot will be removed.

## EXAMPLE:

Hold down the "Turbo" and the "ML" button together for 2 seconds until the LED2 - LED3 lights LED3 lights stay on.

Press the "B" button, after 1 second, press "A", after 3 seconds, press "X". Press the "ML" button to save and exit the setting mode. The button "ML" now is set to perform the actions of: B (after 1s) > A (after 3s) > X.

# TURN ON/OFF RGB LIGHTS

## TURN ON/OFF ABXY BUTTON LIGHTS:

Hold down the "LB+RB" together for 6 seconds to Turn ON/OFF ABXY lights.  
Hold down the "LT+RT" together for 6 seconds to Turn ON/OFF Joystick lights.

Hold down the "LB+RT" together for 6 seconds to Turn ON/OFF Controller side lights. (For Transparent Model Only)

## ADJUST THE BRIGHTNESS:

Hold the "Back" then press the "Up" button on the D Pad to increase the LED brightness.

Hold the "Back" then press the "Down" button on the D-Pad to decrease the LED brightness.

## RGB COLOR MODES

There are three RGB light display modes.

Hold the ""Select" button then press the "Left" button on the D pad to switch between the three light modes.

## MIXED COLOR WAVE (DEFAULT MODE)

The default Mode is a cyclical variation of different colors activated when the controller is turned on.

## COLOR BREATHING MODE

The color automatically breathes and changes every second.

## SINGLE COLOR MODE

Hold the "Select" then press the "Right" button to switch to the next steady color within the Single Color Mode.

## JOYSTICK RGB MODE

Hold the "Back" then press the "Left" button to enter the Joystick Operation RGB Mode.

The joystick RGB lights will light up on moving the joystick and will be off if the joystick has no movements.

The RGB Color Mode is still adjustable when the Joystick RGB Mode is on.

Please make sure the Joystick lights are active before trying to enter the Joystick RGB Mode (Hold down the "LT+RT" together for 6 seconds to switch on/off the joystick lights)

## HOW TO CONNECT CONTROLLER TO DEVICES

This controller offers wireless connectivity with various devices, including Windows PC, Steam Deck PC, Android (Android 10.0 & above), and iOS (13.4 & above) devices.

Please select your preferred connection mode and follow the corresponding steps below.

### ANDROID / D-INPUT PC BLUETOOTH CONNECTION MODE

Step 1: Begin by moving the mode switch to the "Android" position on the back of the controller. Make sure the controller is turned off. To turn off the controller press the sync/pairing button on the top of the controller once.

Step 2: Press and hold the pairing button on the top of the controller for one second to enter Android Bluetooth Pairing mode. The LED lights will start to blink.

Step 3: Activate Bluetooth on your device and choose the detected controller: **"CB Stellaris Controller"**

Step 4: Once the connection is successful, LEDs 2 and 3 will remain steady.

Please Note: The Android Wireless Connection Mode is compatible with PC, Steam Deck, and Android devices running Android 10.0 or later. It will work as D-INPUT Mode on PC.



## PC STEAM DECK ANALOG TRIGGER BLUETOOTH CONNECTION MODE

Step 1: Begin by configuring the mode switch to the "WIN PC" position on the back of the controller. Make sure the controller is turned off. To turn off the controller, press the sync/pairing button on the top of the controller once.

Step 2: Press and hold the pairing button on the controller's top for one second to activate Bluetooth pairing mode.

Step 3: Activate Bluetooth on your PC/Steam Deck and choose the identified controller: **"Pro Controller"**.

Step 4: Upon a successful connection, LED 1 will remain steady.

Please Note: The PC/ Steam Deck Wireless Connection Mode is compatible with PC, Steam Deck, and Android devices running Android 10.0 or later.

In this mode LT and RT will not be pressure sensitive on PC.

## IOS / X-INPUT PC BLUETOOTH CONNECTION MODE

Step 1: Start by setting the mode switch to the "iOS" position on the back of the controller. Make sure the controller is turned off. To turn off the controller, press the sync/pairing button on the top of the controller once.

Step 2: Press and hold the pairing button on the controller's top for one second to activate Bluetooth pairing mode.

Step 3: Enable Bluetooth on your device and select the detected controller: **"Xbox Wireless Controller"**.

Step 4: After a successful connection, LEDs 1 and 2 will remain steady.

Please Note: The iOS Bluetooth Connection Mode is compatible with PC, Steam Deck, Android (10.0 & above) and iOS (13.4 & above) devices.

In this mode LT and RT will be pressure sensitive on PC.

## PC & TESLA DONGLE CONNECTION

Connect the gaming controller to your PC by inserting the USB receiver to your PC USB port, then switch the toggle to Windows mode. Wait for 5-10 seconds. Once connected, the LED indicators 1 will be static.

## MULTI-PLATFORM WIRED CONNECTION

Step 1: Start by adjusting the mode switch to your desired mode: "PC ", "Steam Deck", "Android" or " iOS

Step2: Connect the controller to the target device using a Type C Cable included in the package.

Step 3: The controller will automatically establish a connection. In Android mode, LEDs 1 and 4 will flash, while in iOS and PC modes, LEDs 1 and 3 will flash upon successful connection.

## AUTO SLEEP

On wireless connection, press and hold the home button for 3 seconds, the controller will disconnect and turn on sleep mode. If no button is pressed for 5 minutes; the controller will automatically sleep. The controller will enter sleep mode when the device is also in sleep mode.

## AUDIO FUNCTION

The controller has a 3.5mm audio port, and supports 3.5mm wired headsets or microphones.

Please note that audio port will only work when connected in Wired Mode to PC.

### 3. Rotate the Left and Right Joysticks for 2-3 cycles



### 4. Press the LT and RT Triggers slowly for 2-3 times.

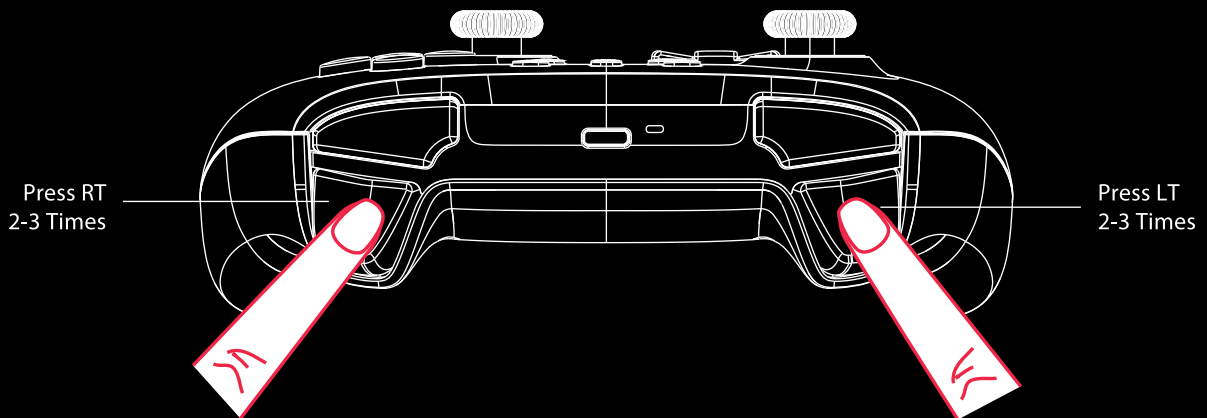

### 5. Press the select button to exit calibration.



The Joystick will be set to default calibration.

## TURN OFF GAMEPAD

Press the sync button once on top of the gamepad to turn off the controller.

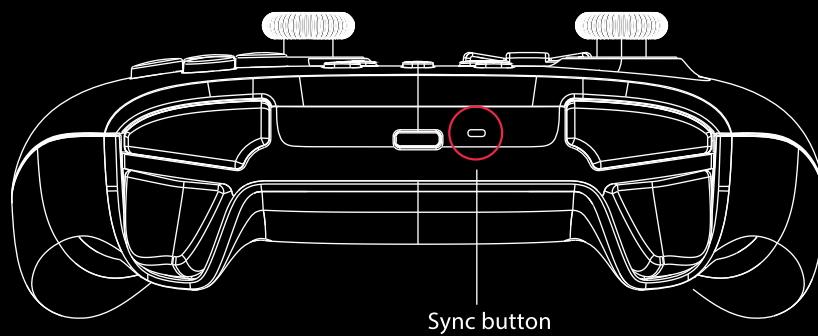

## FUNCTION COMPARISON

	Screenshot	Audio Function	Motion
PC X-INPUT	✗	✗	✗
PC Steam PRO CONTROLLER	✓	*	✓
Android	✗	✗	✗
iOS	✗	✗	✗
Switch Wired	✓	✓	✓
Switch Wireless	✓	✗	✓

\*The audio function works only in the WIRED Pro Controller mode, will NOT work in the wireless Pro Controller mode.

## CHARGING INSTRUCTIONS

The controller can be charged using the 5V 2A power adapter, or USB power supplies with the USB Type C to A cable. Using any fast chargers or adapters of other specifications can damage the controller and will not be covered under warranty.

If the controller is connected with the console while charging, the corresponding channel LED light(s) on the controller will flash. The channel LED light(s) will stay lit if the controller has been fully charged. If the controller is not connected with the console while charging, the 4 LED lights will flash. The LED lights will turn off when the controller has been fully charged.

When the battery is low, the corresponding channel LED light(s) will flash; the controller will turn off and need to be charged if the battery is drained.

## FIRMWARE UPDATE

Please follow these steps to update your controller's firmware through the " Key Linker " app:

Step 1: Download the " key Linker " app from your mobile app store.

Step 2: Press and hold the SYNC button on the controller until the indicators flash quickly.

Step 3: Turn on your mobile device's Bluetooth and pair it with the controller named "Pro Controller".

Step 4: Open the "Key Linker " app and refresh Connect with the device " PRO CONTROLLER " to start using the app's features.

Now you can customize the functions and upgrade the firmware of your controller through the app.

Step 5: Select "Update Device from the menu of the app.

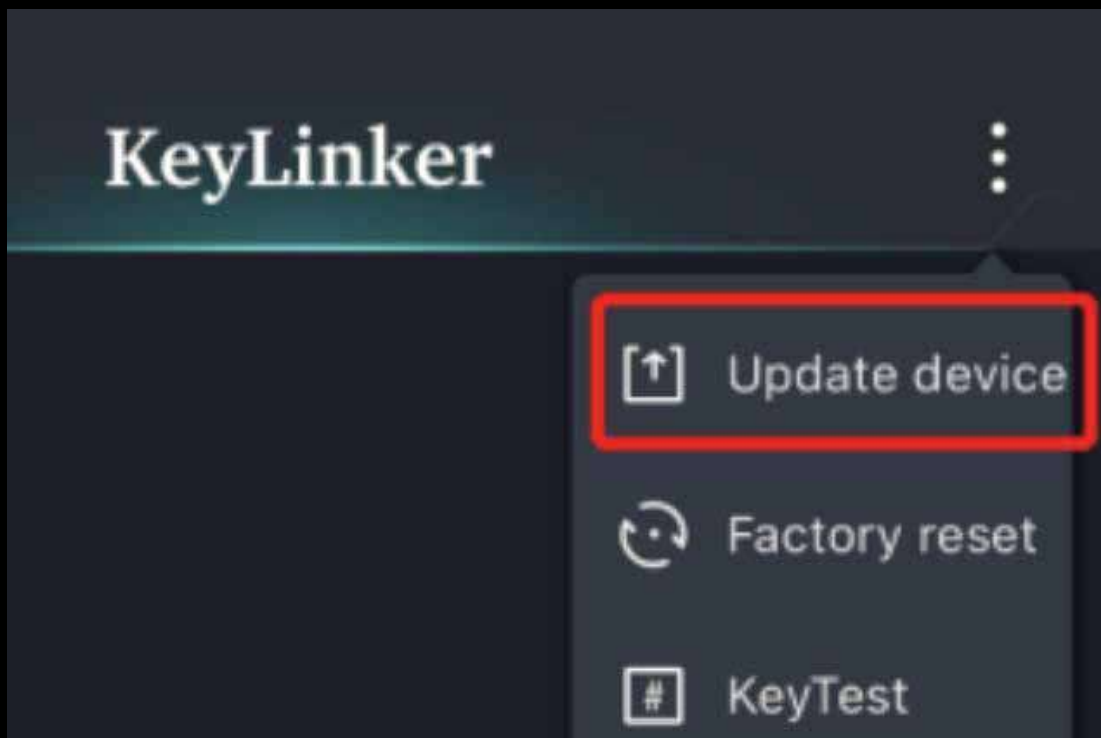

Step 6: If a new version is available, click "Update Now" and then select "Yes" when the updating tips pop up.

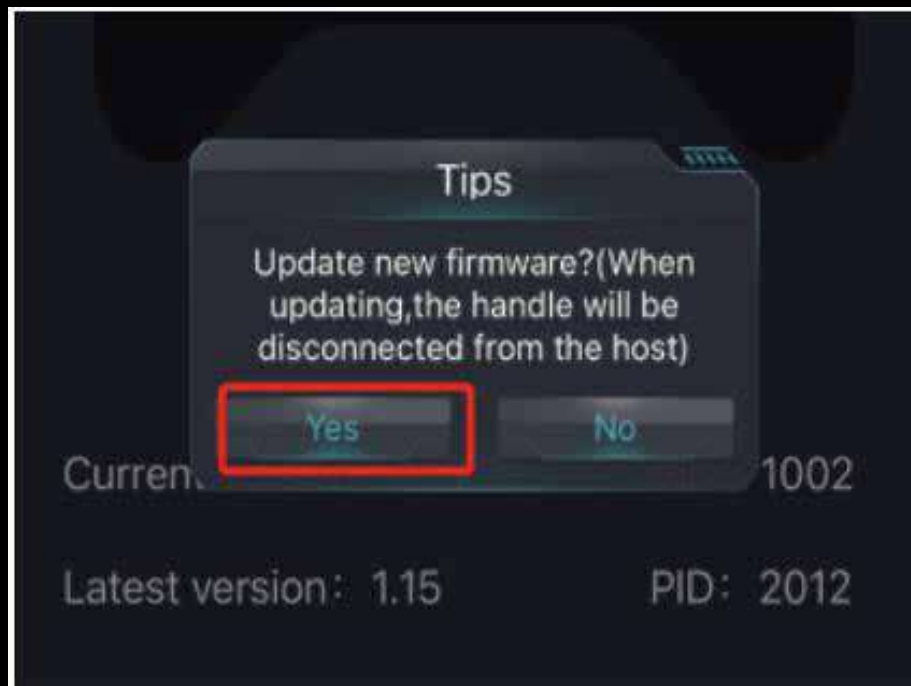
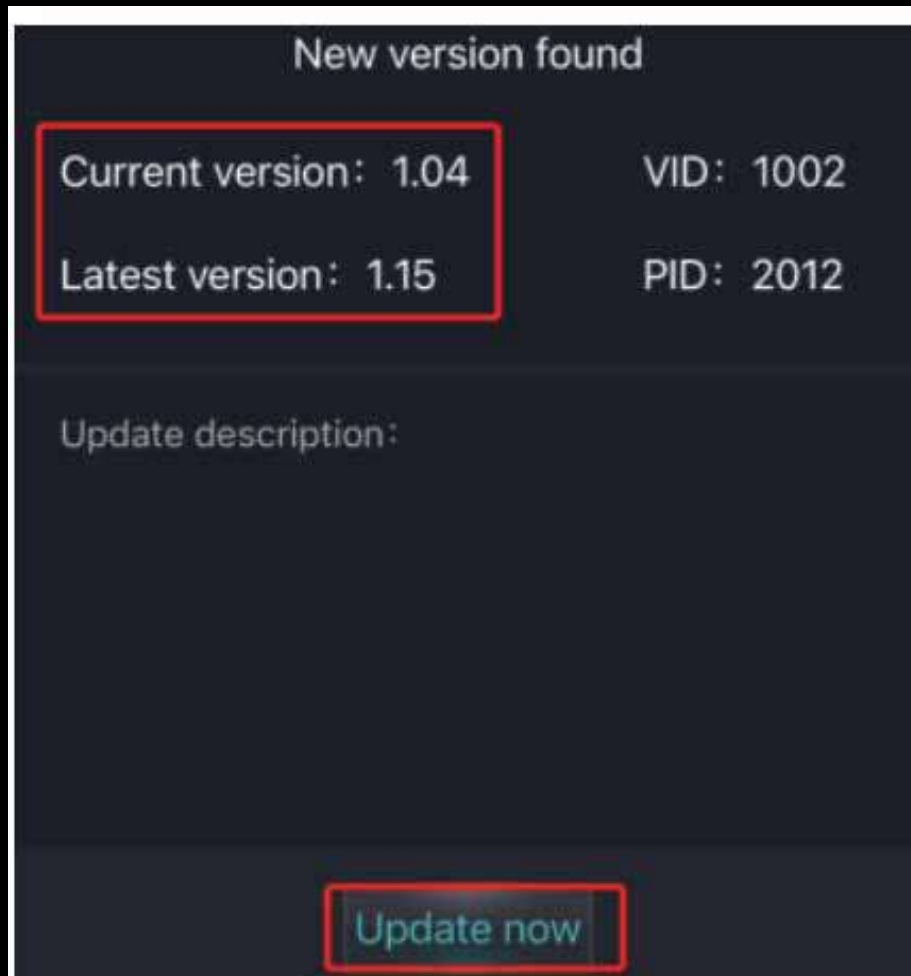

Step 7: The firmware will be updated successfully and then restart your device and app.

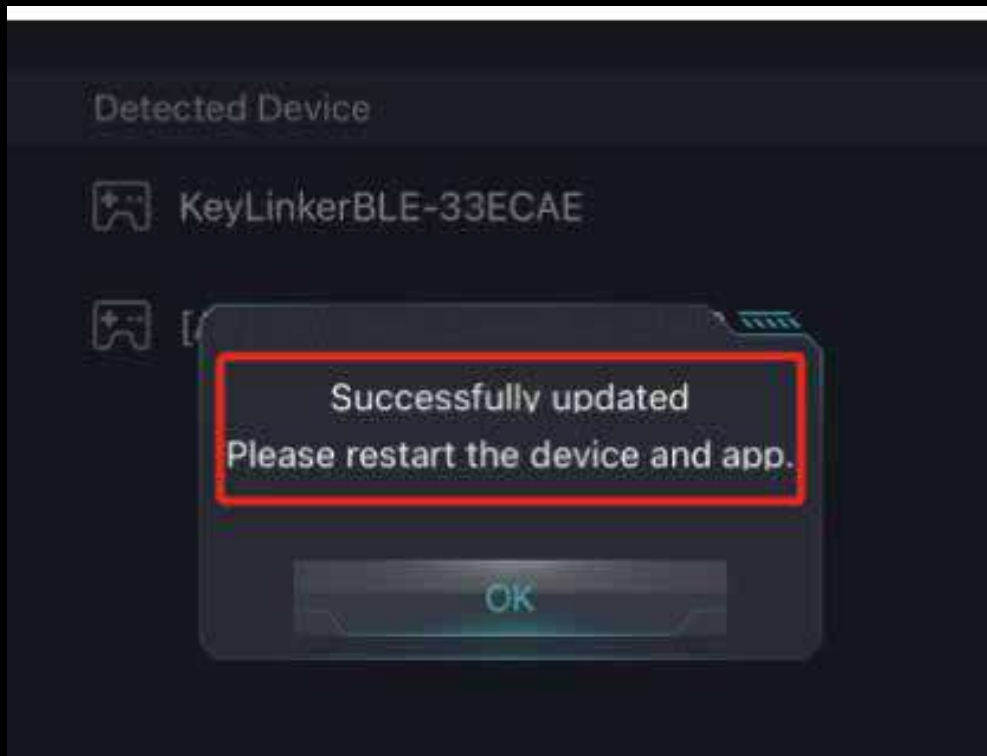

Please Note: The upgraded firmware is to fix some occasional bugs. You don't need to update it unless your controller has problems in use. There is no functional difference between the upgraded versions.

## HOW TO FACTORY RESET THE CONTROLLER SETTINGS

Press the "Turbo" and "Back" button for 6 seconds to reset the controller to factory settings if you have any issues with using the controller.

## HOW TO FACTORY RESET THE CONTROLLER HARDWARE

Hold the "Home" button for 10 seconds.



# HOW TO RE-CALIBRATE JOYSTICKS

If you face any drift error, you can recalibrate the joystick to default settings.

Please follow the steps below.

**1. Move the Trigger switches on the back of the controller to the short distance mode.**

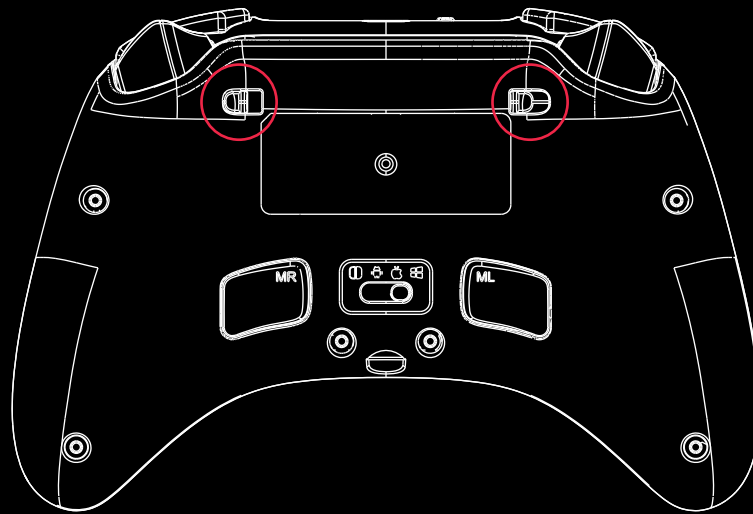

**2. Press Turbo + Start + Select button to enter calibration**



# HOW TO CHECK BATTERY LEVEL OF THE CONTROLLER

Press "Turbo" and "Back" button once. The LED indicators on the controller will indicate the battery level.

Action	Duration	Type	Setting
Home	Hold for 10 Seconds	Reset	Reset the controller hardware
Turbo +   (Left Joystick Up)	Hold the Turbo and pull up the L joystick	Vibration	Increase the controller vibration intensity
Turbo +   (Left Joystick Down)	Hold the Turbo and pull down the L joystick		Decrease the controller vibration intensity
L1 + L2	Hold together for 6 Seconds	RGB	Turn on/off ABXY button lights
ZL + ZR	Hold together for 6 Seconds		Turn on/off Joystick lights
+	Hold the  and press		Increase the RGB Light brightness
+	Hold the  and press		Decrease the RGB Light brightness
+	Hold the  and press		Change between the three RGB light modes
+	Hold the  and press		Change the color within the Single Color Mode
+	Hold the  and press		Enter / Exit the joystick Operation RGB Mode
A/B/X/Y/L1/L2/R1/R2 + Turbo	Hold the targeted button, press Turbo		Turbo
Turbo	Hold for 6 Seconds	Clear the Turbo setting for all the buttons	
Turbo + ML for two seconds. Button need to be set to, ML		Macro	Set the macro definition (map) for ML
Turbo + MR for two seconds. Button need to be set to, MR			Set the macro definition (map) for MR
Turbo + ML for two seconds, ML			Clear the macro definition (map) for ML
Turbo + MR for two seconds, MR			Clear the macro definition (map) for MR
Turbo +	Hold together for 6 Seconds	Factory Reset	Reset to the factory settings (ML/MR to A/B, 70% Vibration, Turbo speed 15 shots/s)
Turbo +	Press together briefly	Battery	Clear the controller battery level with the LED indicators.

## SUPPORT DETAILS

Phone: 07969273222 (Mon-Sat 10:00AM to 6:00 PM)  
Email: [cc@thecosmicbyte.com](mailto:cc@thecosmicbyte.com)  
FAQ: [support.thecosmicbyte.com](https://support.thecosmicbyte.com)

## WARRANTY

The Controller carries 1 Year warranty against manufacturing defects only. Physical, Water damage and Tampered products are not covered under warranty. Regular wear and tear from battery usage is not covered under warranty.



Scan the QR code to know the Warranty Claim Procedure.

## FAQ'S

[support.thecosmicbyte.com](https://support.thecosmicbyte.com)